

# La monnaie libre

Ĝ1

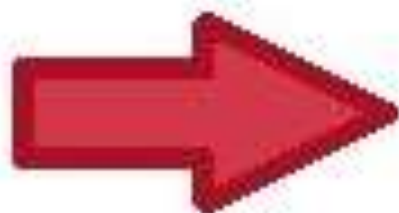







# Fable





# La monnaie

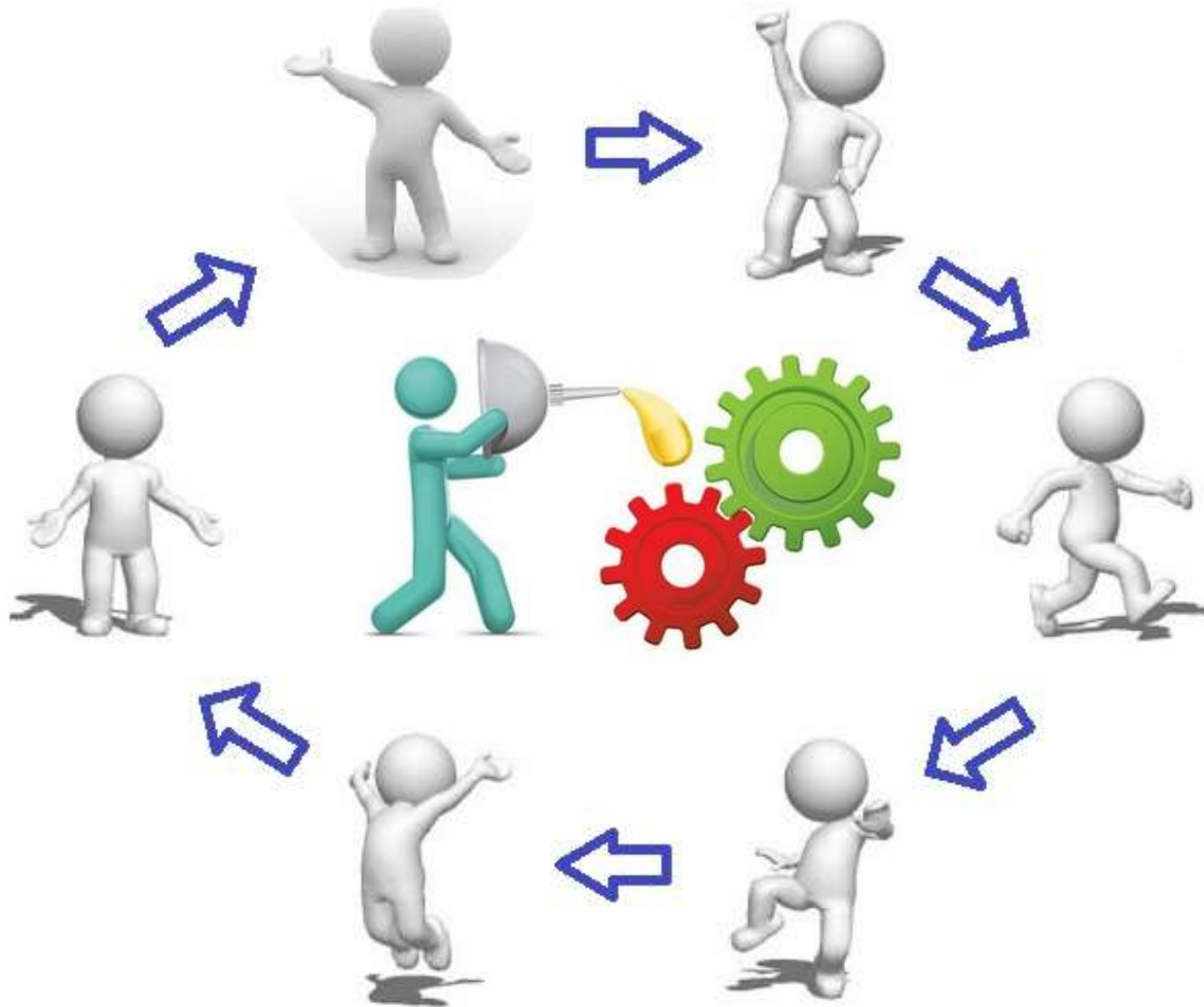









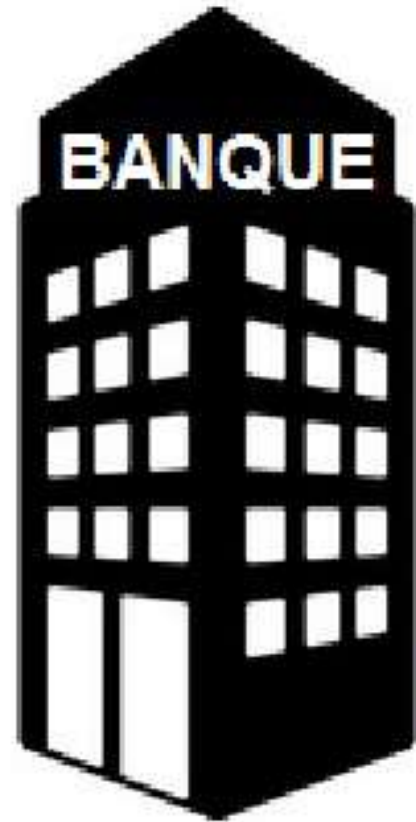



**DETTE**





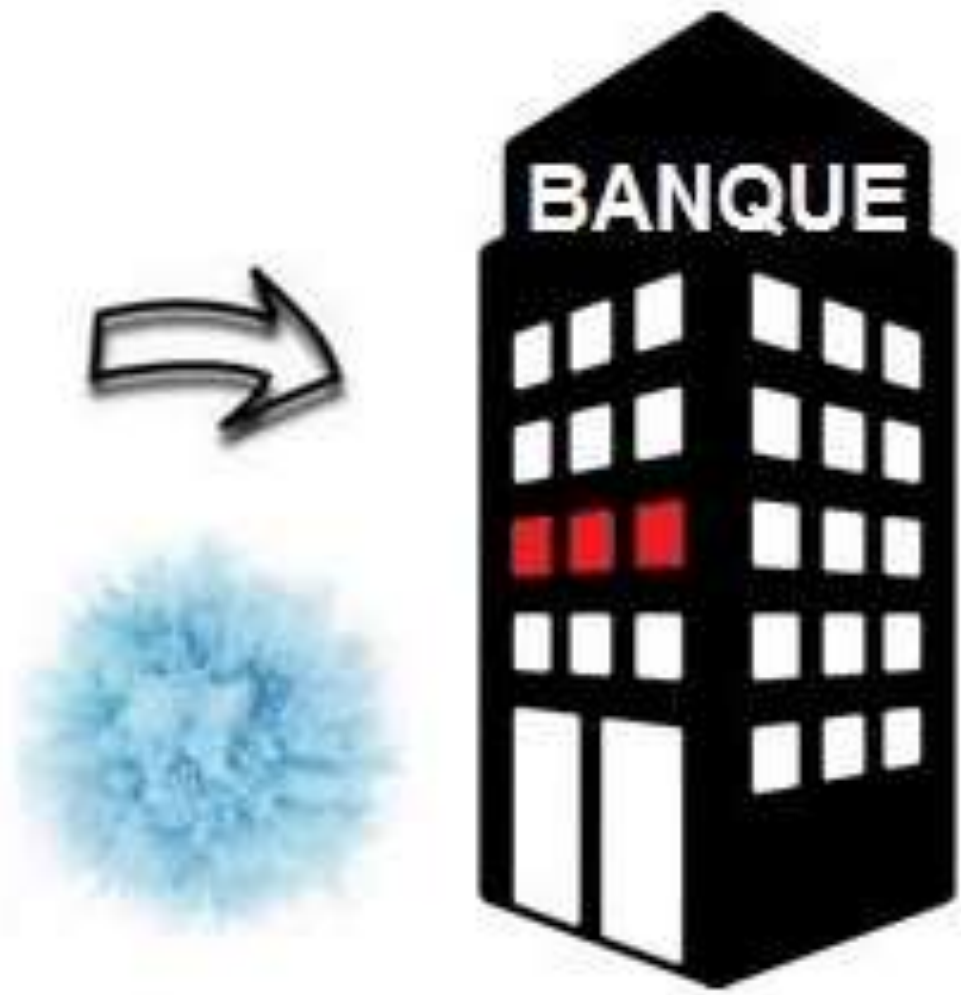





**Banques  
privées**









**dividende  
universel**

**DU**

- 1. L'accès à la monnaie est gratuit, et identique pour tous.**
- 2. La masse monétaire augmente constamment.**
- 3. Si vous ne vendez et n'achetez rien, votre part de la masse monétaire se rapproche de la moyenne.**

# Ajout quotidien de 10 Ğ1

**Jour 1**

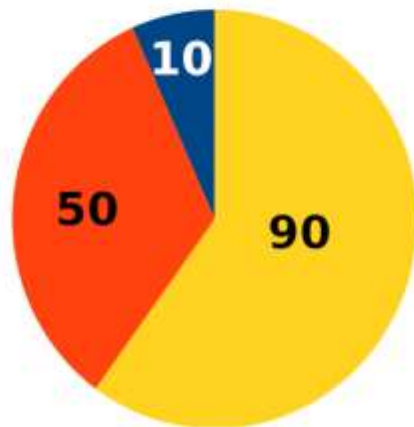

**Total 150**

**Jour 4**

Chacun a reçu 30

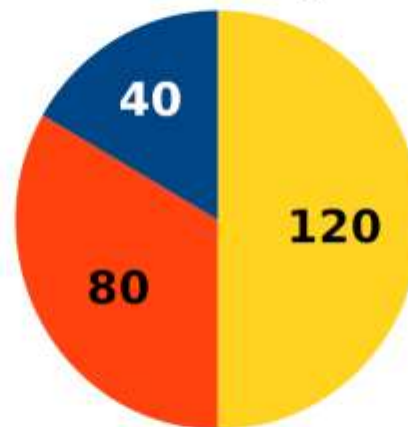

**Total 240**

**Jour 16**

Chacun a encore reçu 120

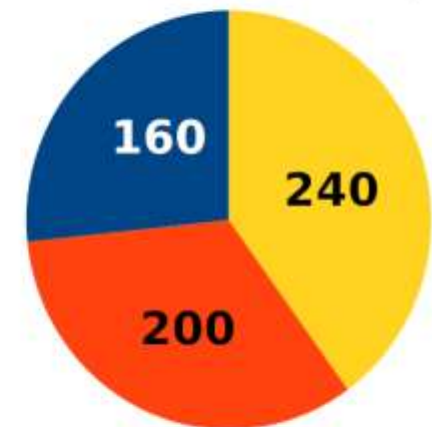

**Total 600**

■ Aline  
■ Bruno  
■ Claude

# Redistribution

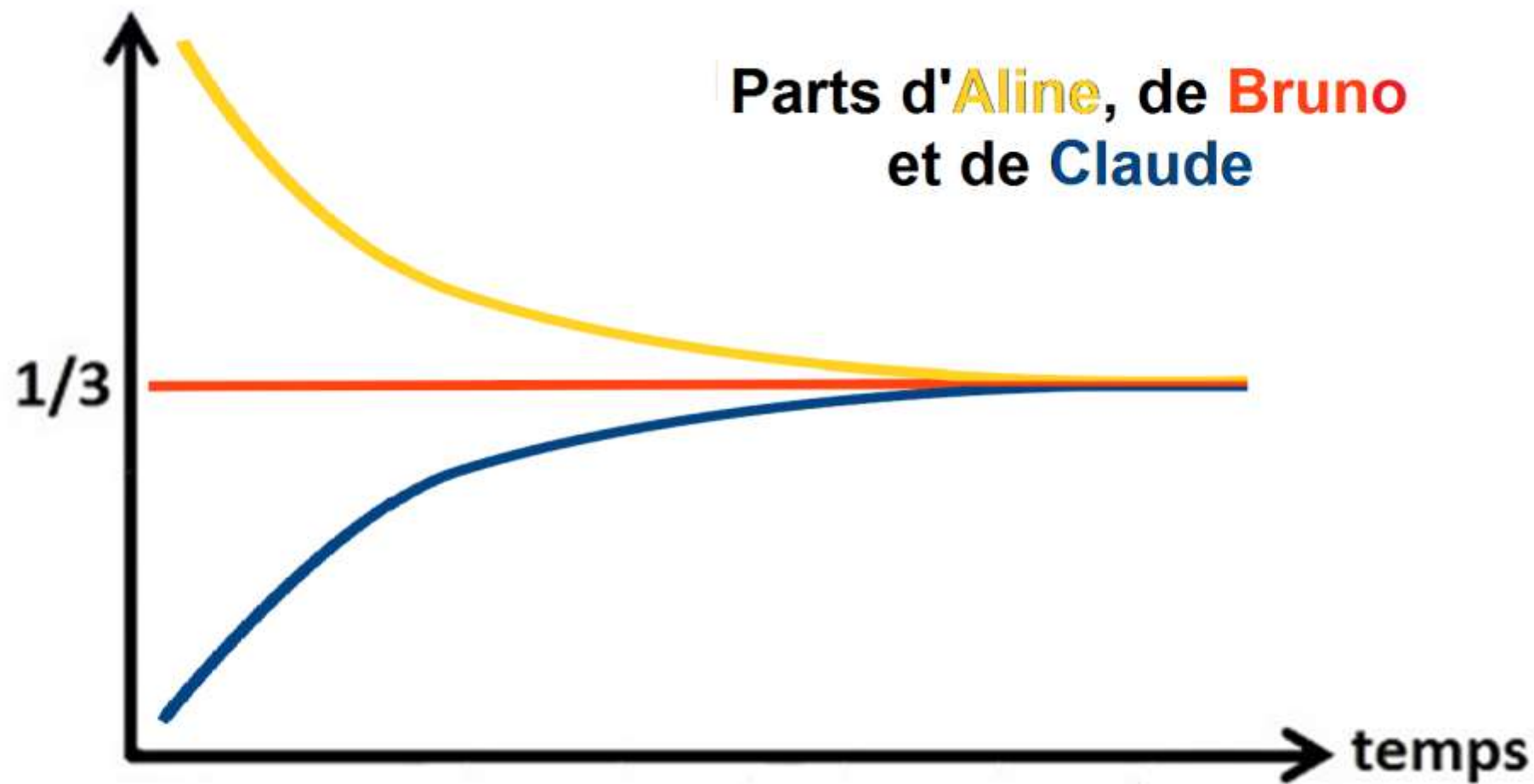

# Redistribution

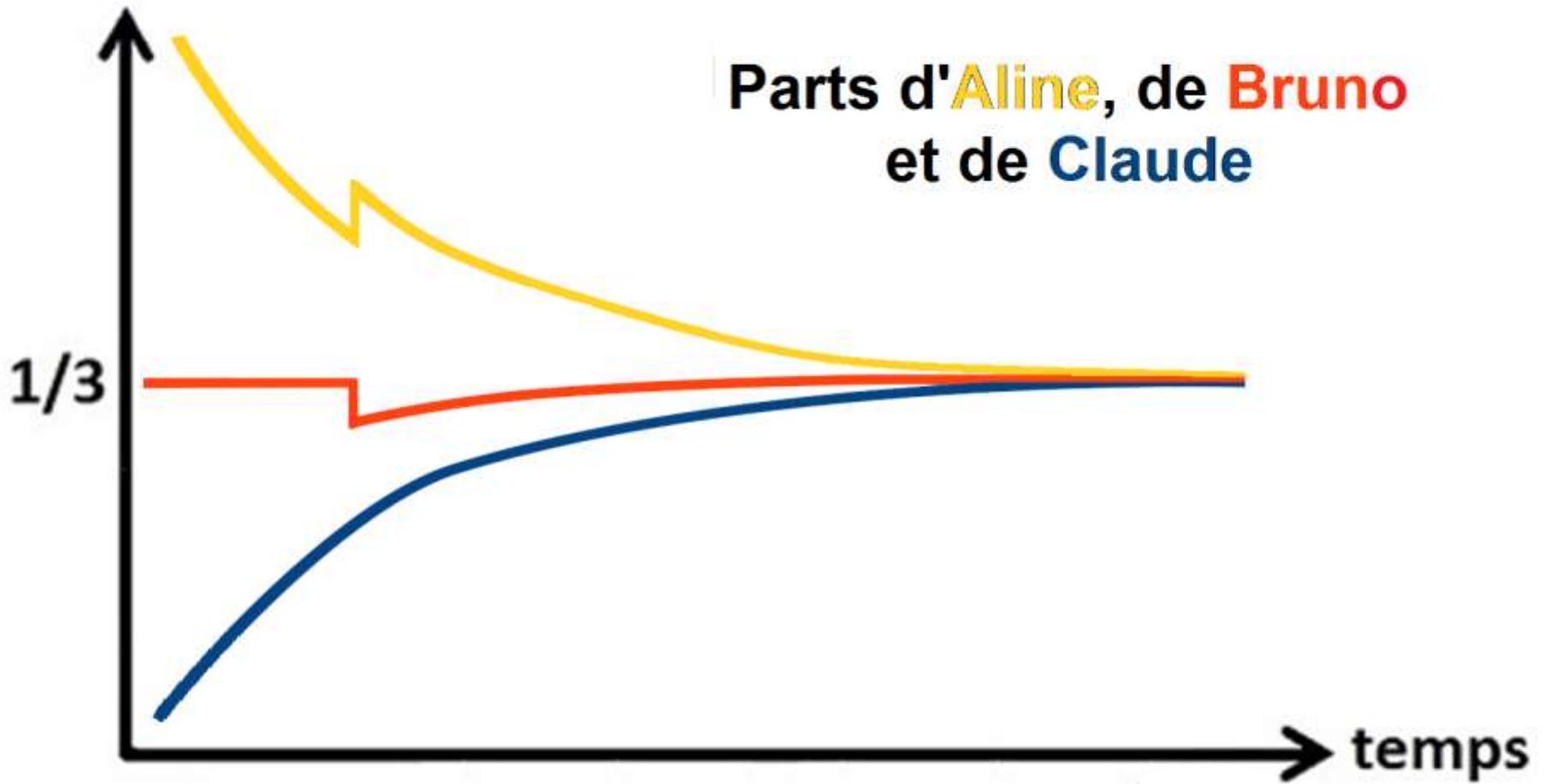



# Redistribution

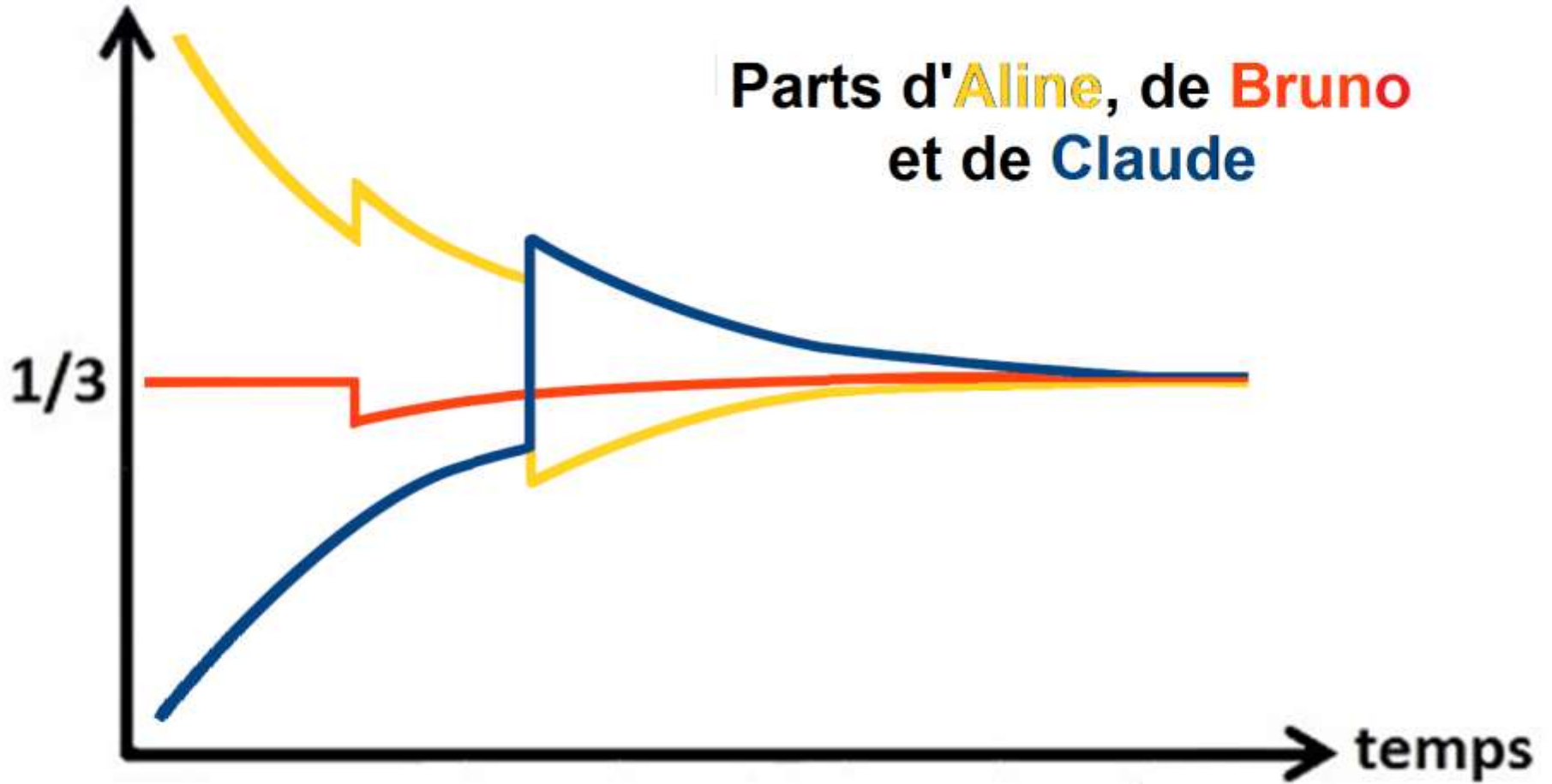

**1. L'accès à la monnaie est gratuit, et identique pour tous.**

**2. La masse monétaire augmente constamment.**

**3. Si vous ne vendez et n'achetez rien, votre part de la masse monétaire se rapproche de la moyenne.**





~~10 Ğ1~~  
10,5 Ğ1





**Masse monétaire**

# RSA

**Revenu de solidarité active,  
Indexé sur l'inflation de l'€**



# Unités relatives





# Unités relatives



~~10 Ğ1~~  
10,5 Ğ1

1 DU





Inflation







# Sécurité



**Un tonneau ou une source ?**

Sécurité

Universalité

Inconditionnalité

**Revenu de base ?**



Sécurité  
Universalité  
Inconditionnalité

## Revenu de base :

Émancipation

Dignité  
Indépendance  
Diversification







**Entrer dans la  
monnaie libre**

# **Vous pouvez vendre et acheter dès demain**

## **Avec un compte portefeuille**

- Procédure décrite plus loin
- Pas de DU

# Petites annonces



31 - **Légumes** bio – livraison jeudi 24/09 – commande avant mercredi 23/09 20h

📍 Saint-Geniès-Bellevue, 31180

🕒 il y a 2 mois par Gaëlle Mory

Fruits & **Légumes**

📄 Offre



Vente plants de plantes médicinales et autres entre 10 et 20 junés selon les espèces

📍 Le Lamentin, 97232

🕒 il y a 6 jours par Coeur Végétal

Fruits & **Légumes**

📄 10,00 €



Butternets - Potirons - Confiture de Figues - Ketchup maison

📍 Martigues

🕒 il y a 2 mois par James Howlett

Fruits & **Légumes**

📄 19,415 m €



ORANGES PREMIÈRE ANNÉE

📍 Ouveillanpres de Narbonne

🕒 il y a un mois par CATANESE Jane

Fruits & **Légumes**

📄 Offre



Ail de Naples comestible ( une vingtaine de bulbes )

📍 Narbonne, 11100

🕒 il y a 2 mois par zaza

Fruits & **Légumes**

👤 10 ✓

📄 20,00 €

# Toile de confiance

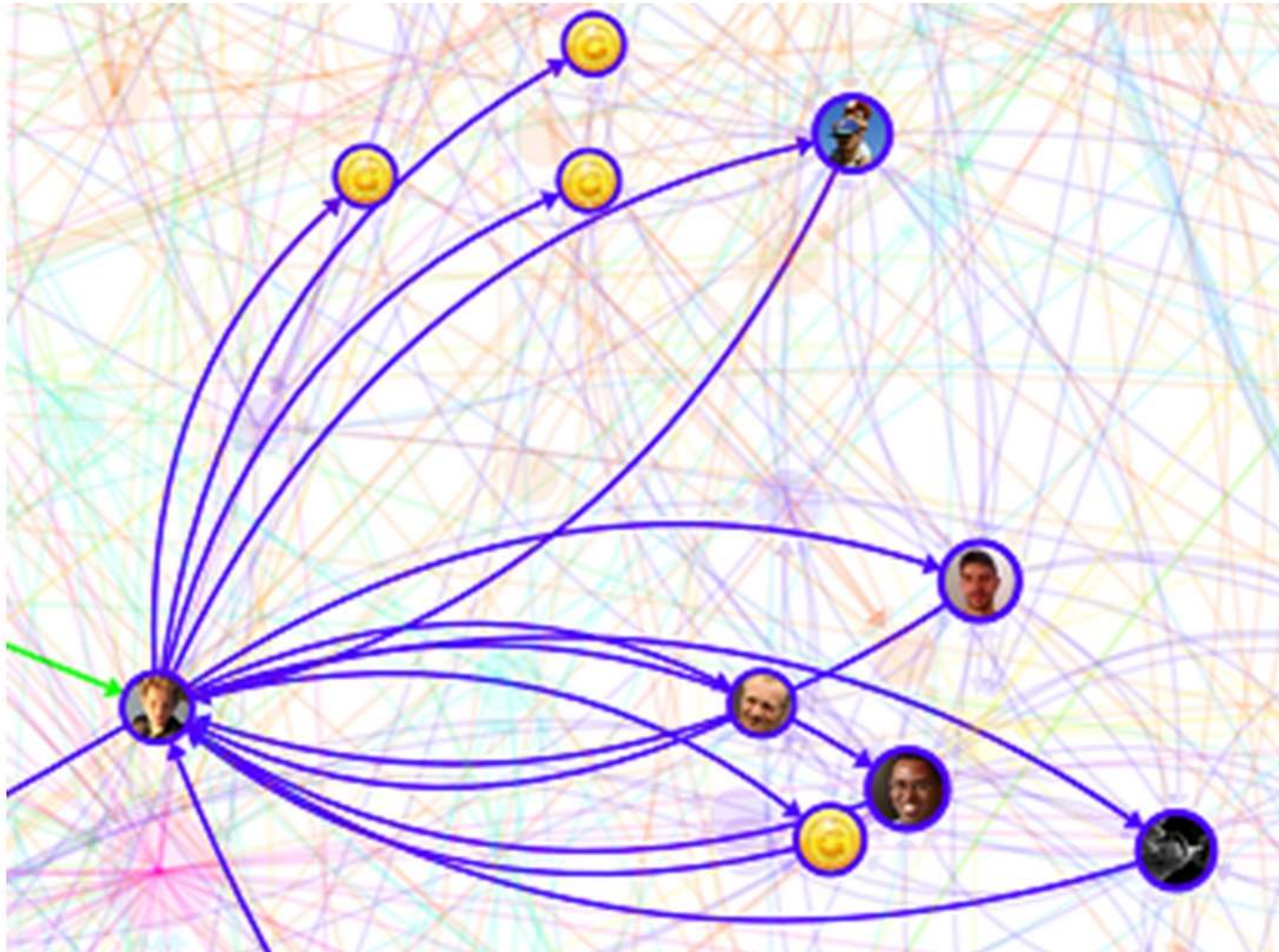



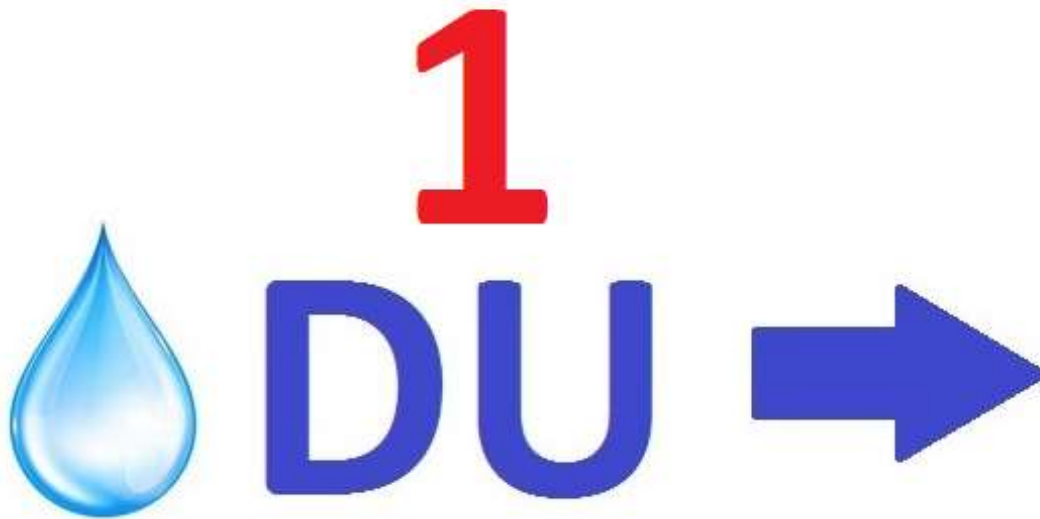

**dividende universel**







**Cinq certifications**



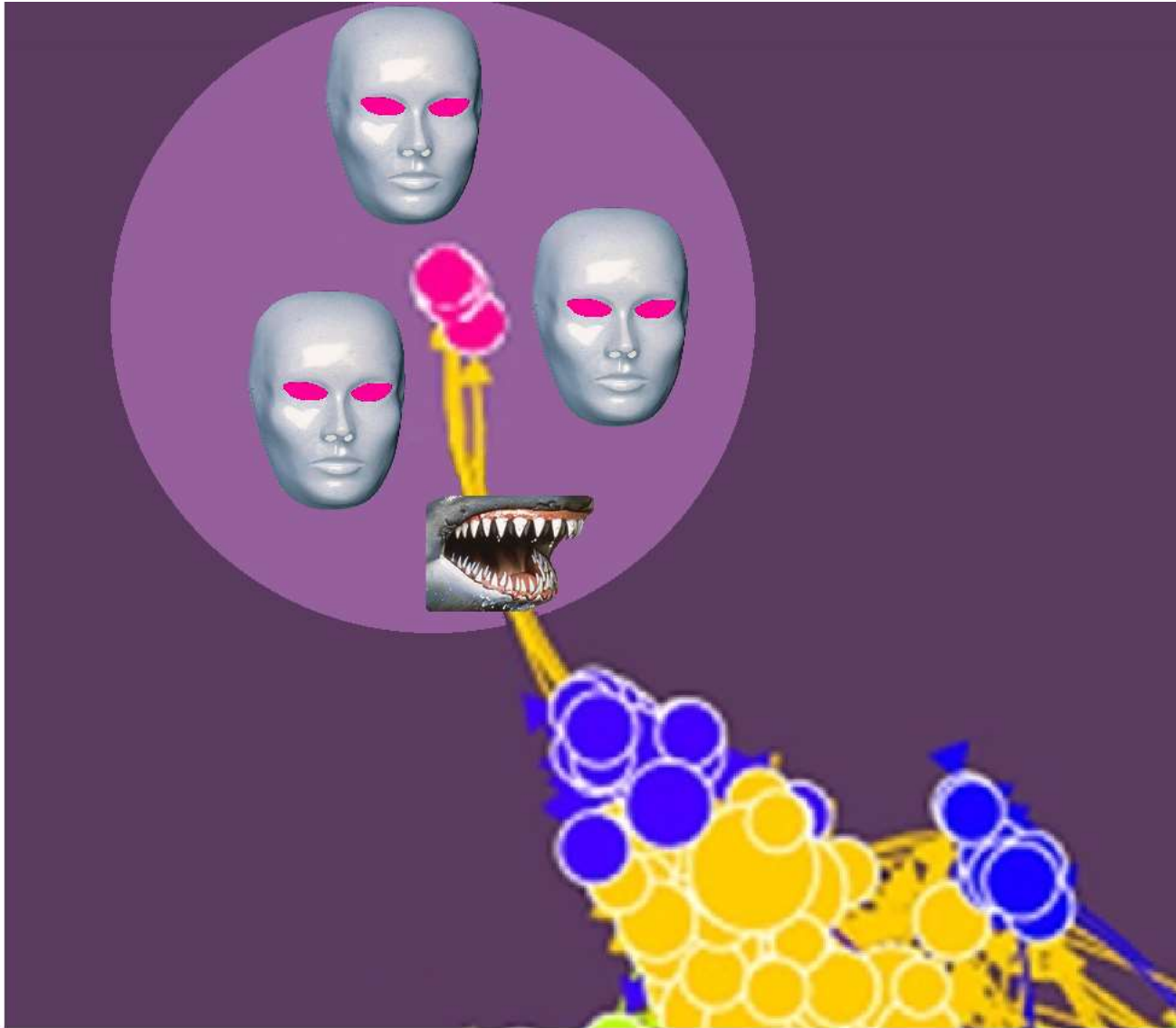

# Une toile compacte

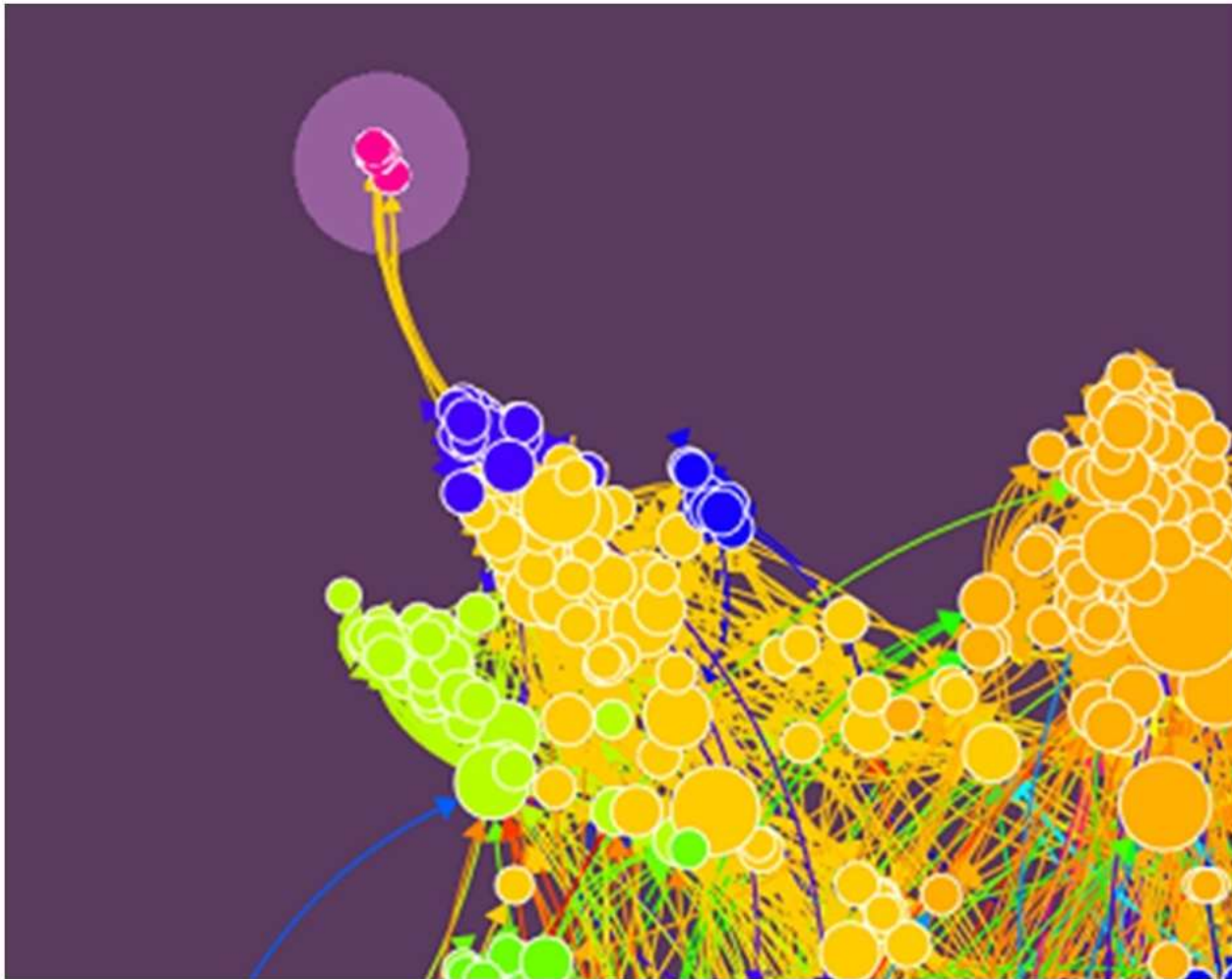

Règle de distance



**Comment faire**

# Comment faire

## 1. Créer un compte portefeuille



Cesium.app



# Comment faire

## 1. Créer un compte portefeuille



a) Deux phrases de passe

# Comment faire

## 1. Créer un compte portefeuille



a) Deux phrases de passe

~~Procédure « mot de passe perdu »~~

# Comment faire



## 1. Créer un compte portefeuille

a) Deux phrases de passe

~~Procédure « mot de passe perdu »~~

b) Clé publique

# Comment faire



## 1. Créer un compte portefeuille

a) Deux phrases de passe

~~Procédure « mot de passe perdu »~~

b) Clé publique

Transactions possibles

# Comment faire

**1. Créer un compte portefeuille**



**2. Obtenir 5 promesses de certification**

# Comment faire

**1. Créer un compte portefeuille**



**2. Obtenir 5 promesses de certification**

... avant de passer au point 3

# Comment faire

**1. Créer un compte portefeuille**



**2. Obtenir 5 promesses de certification**

**3. Demander l'adhésion et les certifications**

# Comment faire

**1. Créer un compte portefeuille**



**2. Obtenir 5 promesses de certification**

**3. Demander l'adhésion et les certifications**

Document de révocation



# Comment faire

**1. Créer un compte portefeuille**



**2. Obtenir 5 promesses de certification**

**3. Demander l'adhésion et les certifications**



Chaque certification est valide 2 ans

# Comment faire

1. Créer un compte portefeuille



2. Obtenir 5 promesses de certification

3. Demander l'adhésion et les certifications



4. Donner signe de vie { Renouveler après 1 an

# Comment faire

1. Créer un compte portefeuille



2. Obtenir 5 promesses de certification

3. Demander l'adhésion et les certifications



4. Donner signe de vie {  
Renouveler après 1 an  
Après 2 ans : 

# Comment faire

**1. Créer un compte portefeuille**



**2. Obtenir 5 promesses de certification**

**3. Demander l'adhésion et les certifications**



**4. Donner signe de vie**

**Pas de procédure  
« mot de passe perdu »**

Pas d'autorité centrale



cgeek



elois



Hugo



kimamila



Matograine



1000i100



Moul



poka



tuxmain



vit

# **Pas de procédure « mot de passe perdu »**

En cas de perte, il faut  
révoquer le compte

# Architecture

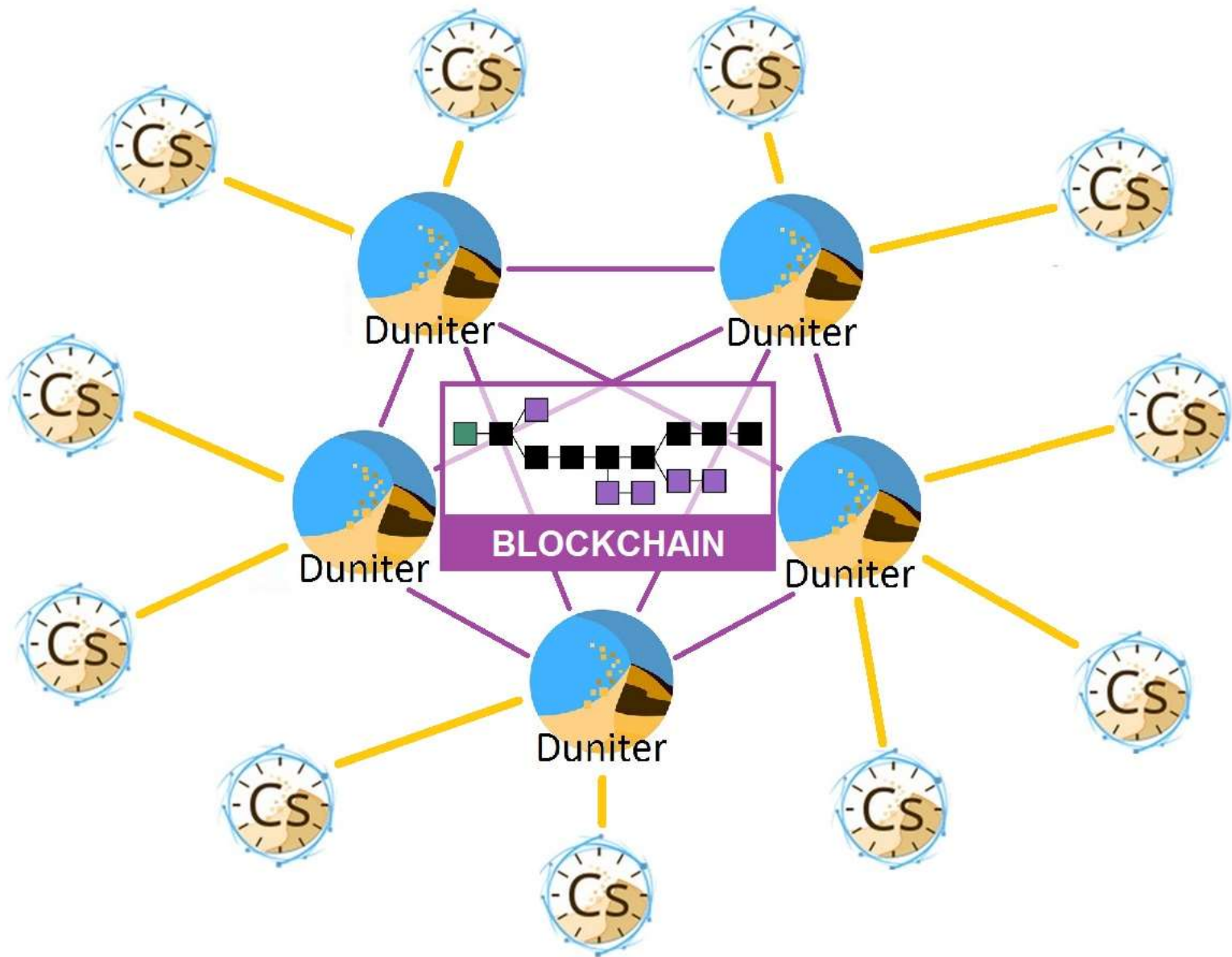





Certifications

Dividendes

Virements

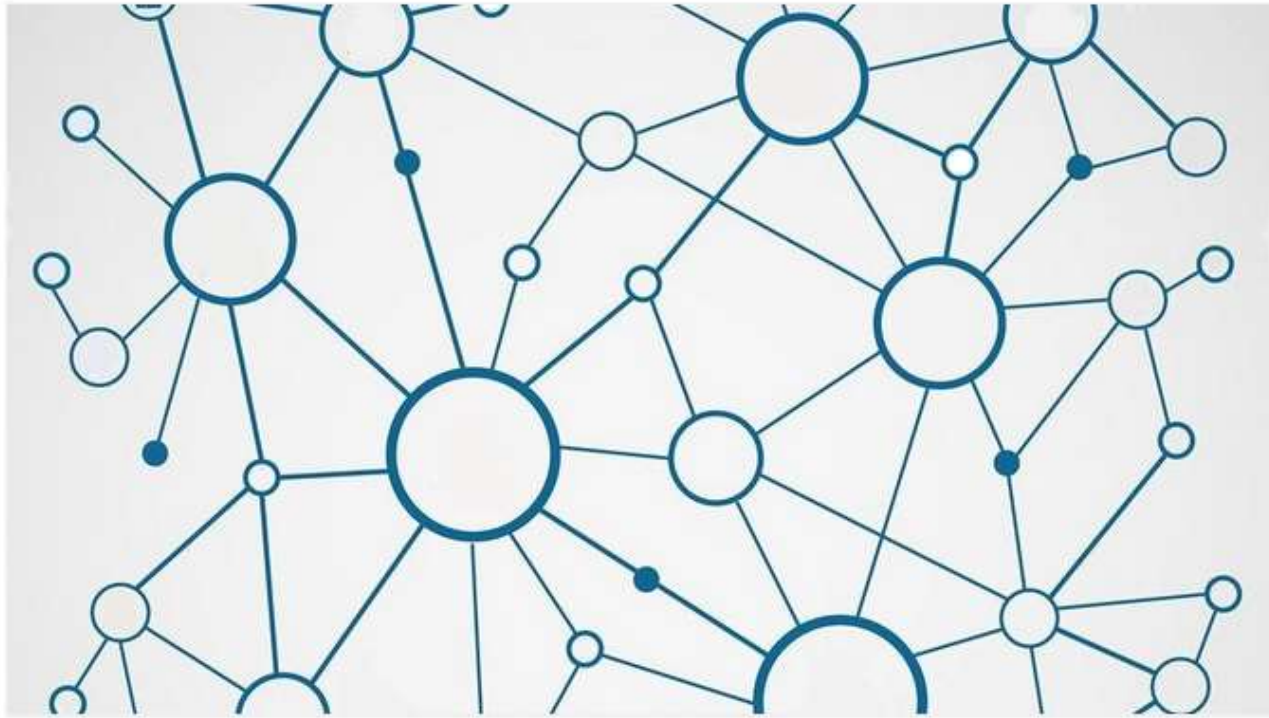
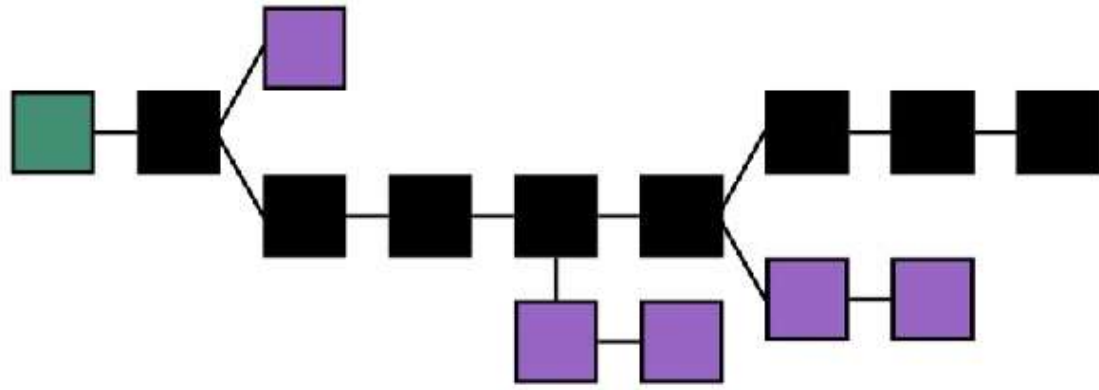

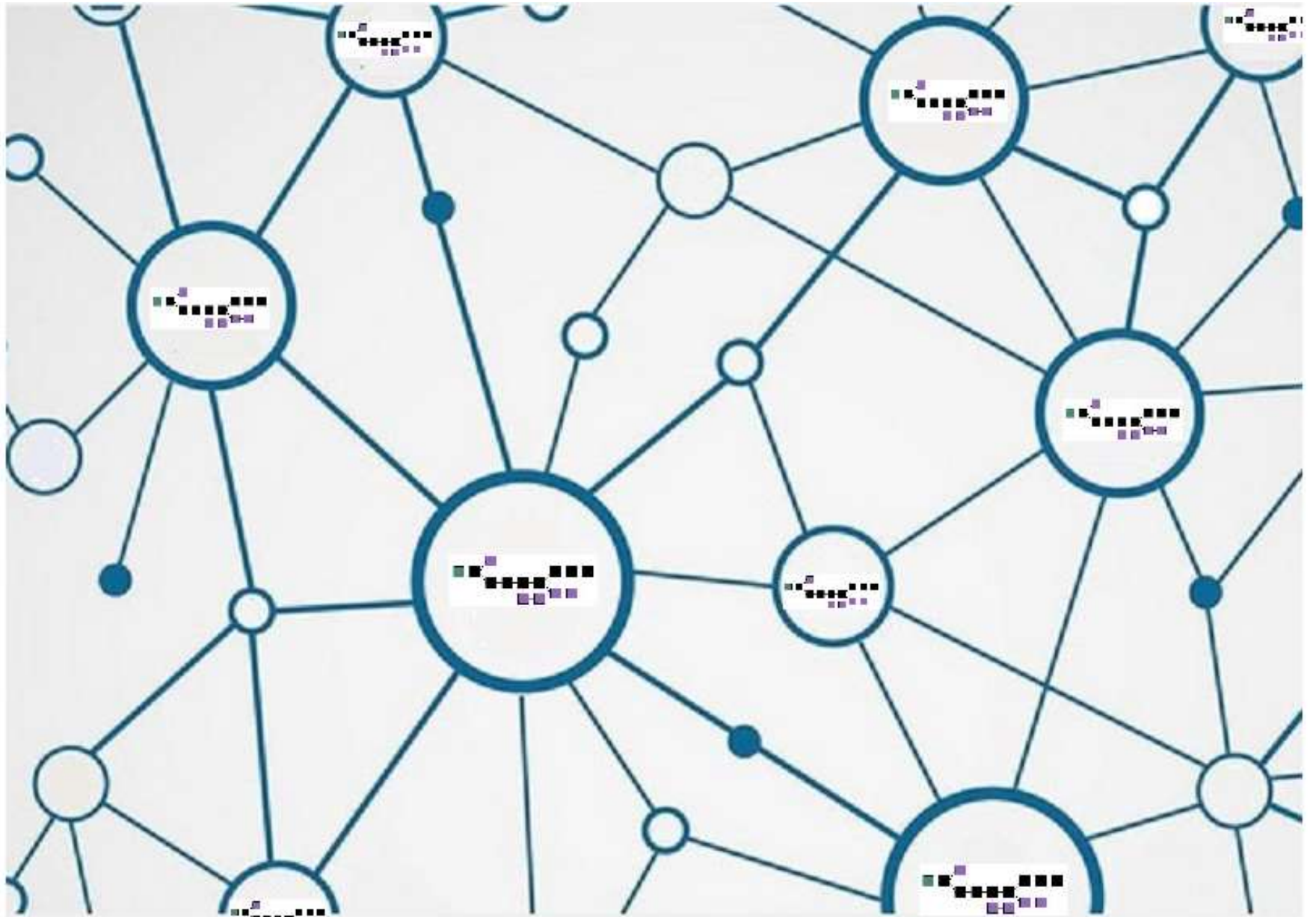



**Cryptomonnaies**

# Les monnaies libres



La théorie relative de la monnaie, par Stéphane Laborde : <http://trm.creationmonetaire.info/>

La TRM pour les enfants, par Cuckooland :  
<http://cuckooland.free.fr/LaTrmPourLesEnfants.pdf>

Forum : <https://forum.monnaie-libre.fr>

Cesium : <https://cesium.app/telechargement>

**Cette présentation en vidéo :**  
**[vimeo.com/corinne/](https://vimeo.com/corinne/)**  
**lamonnaielibresansjargon**

Avec de nombreux liens en description